

[This Drawing is a reproduction of the Original on a reduced scale.]

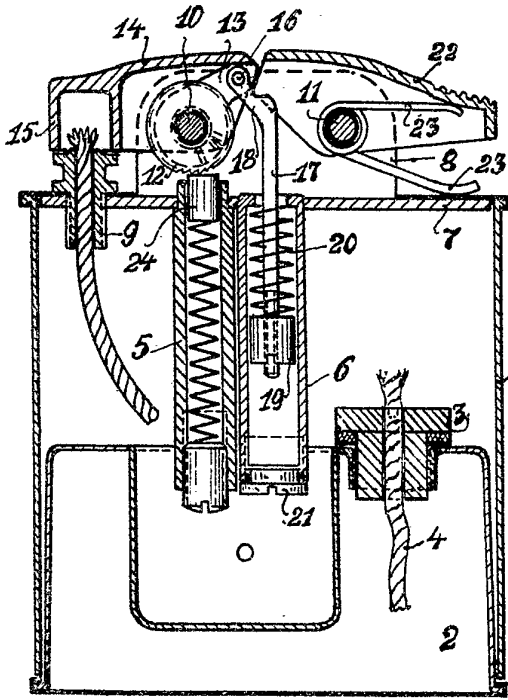

Fig. 1.

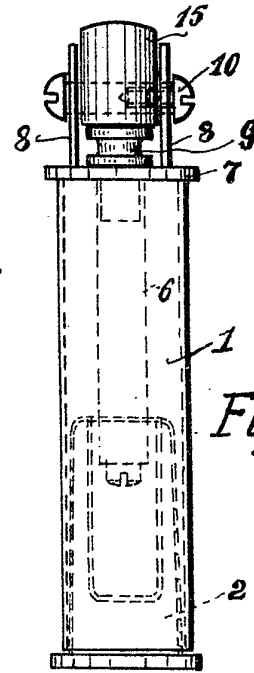

Fig. 2.

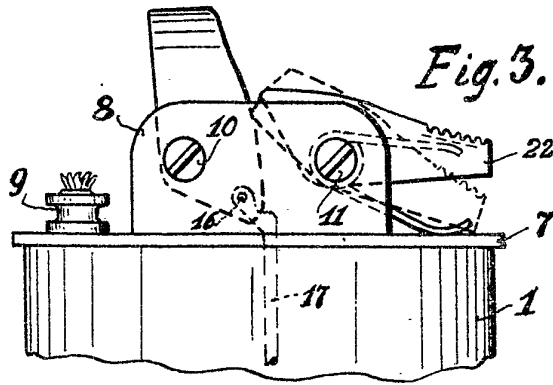

Fig. 3.