

[This Drawing is a reproduction of the Original on a reduced scale.]

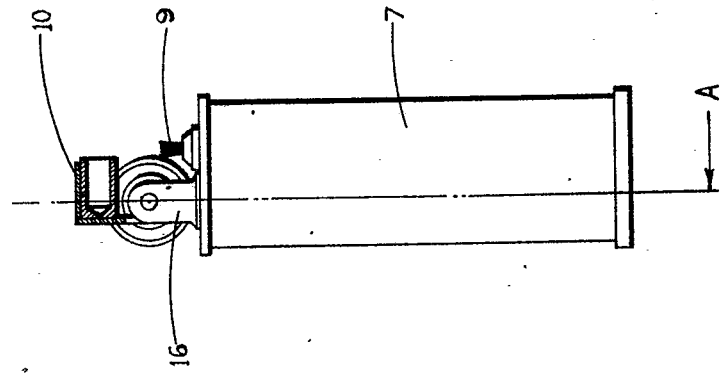

FIG. 1.

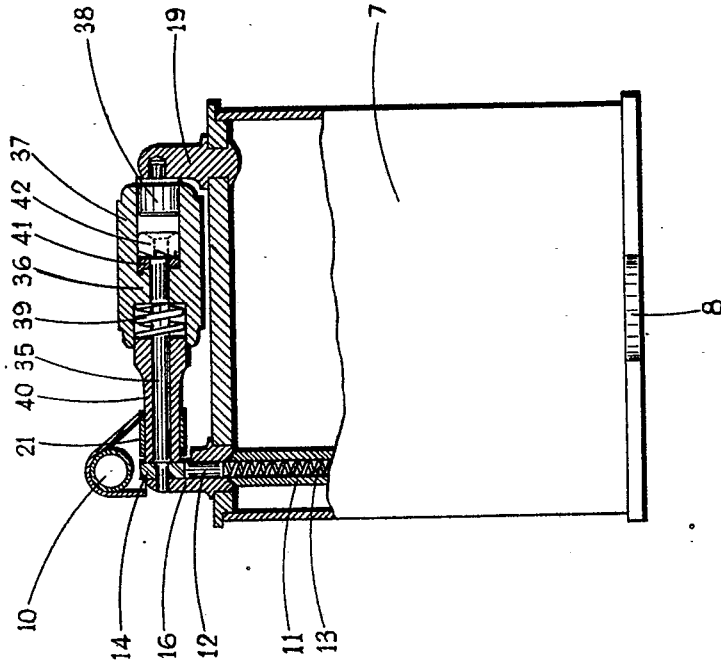

FIG. 2.