

July 3, 1934.

L. V. ARONSON

1,965,275

IGNITER TORCH

Filed Dec. 22, 1933

Fig. 1.

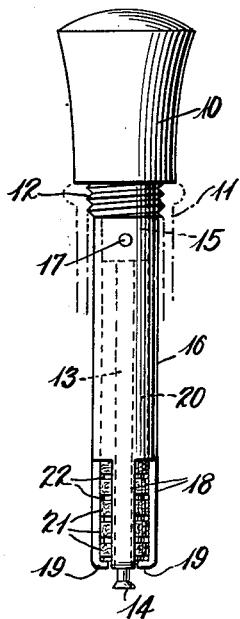

Fig. 3.

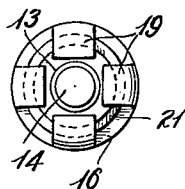

Fig. 6.

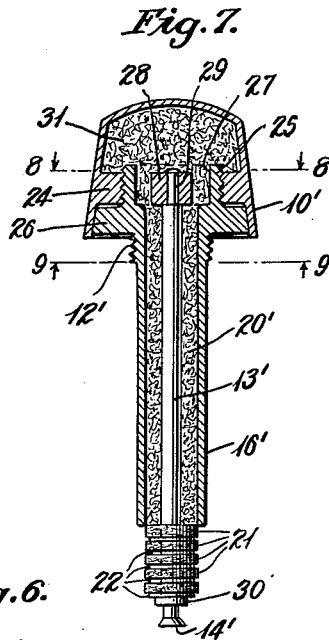

Fig. 8.

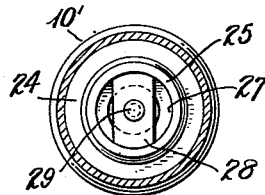

Fig. 4.

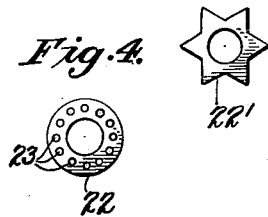

Fig. 5.



Fig. 9.

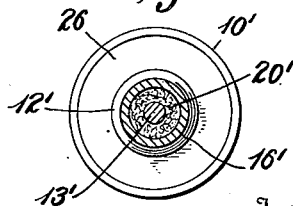
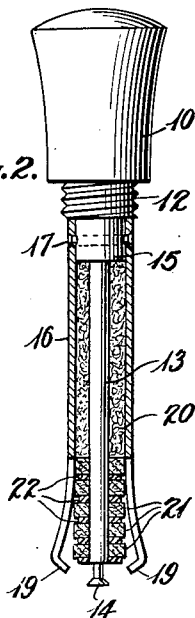

Fig. 2.



Inventor

Louis V. Aronson

Brown & Phelps

Attorneys