

Fig. 1

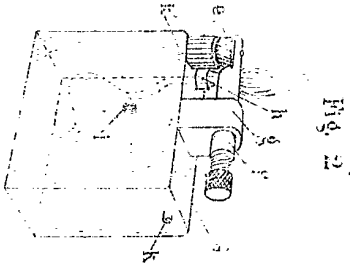

Fig. 2

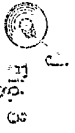

Fig. 3

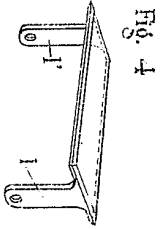

Fig. 4

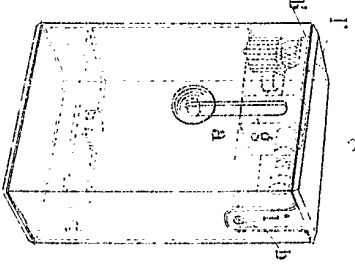

Fig. 5

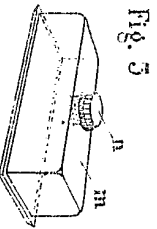

Fig. 6

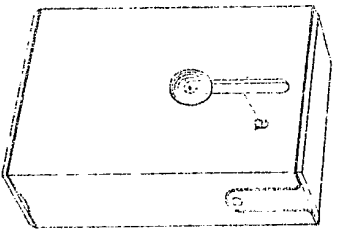

Fig. 7

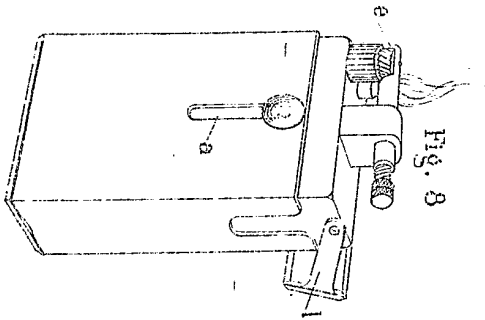

Fig. 8

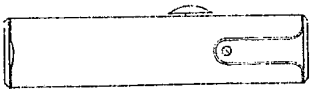

Fig. 9

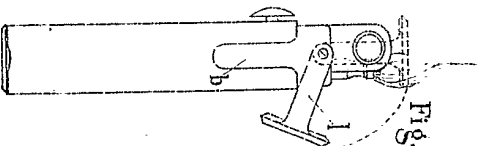

Fig. 10

Fig. 1

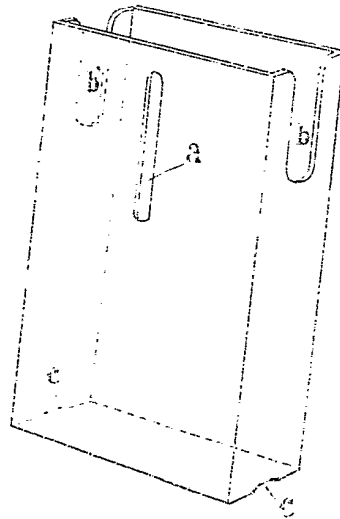

Fig. 2

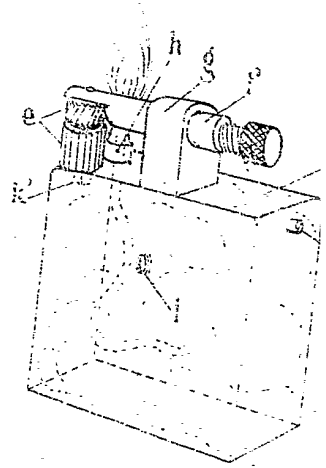

Fig. 4

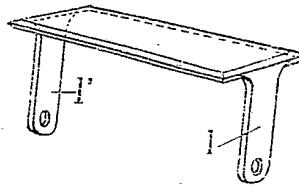

Fig. 3



Fig. 6

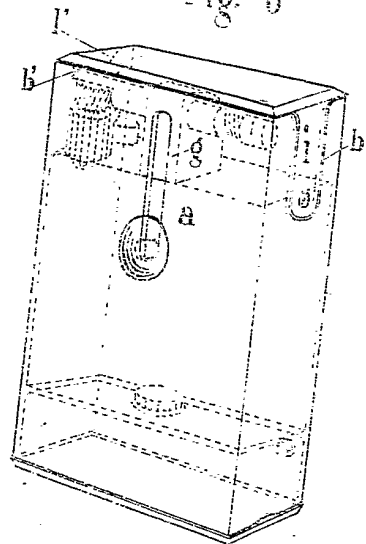

Fig. 5

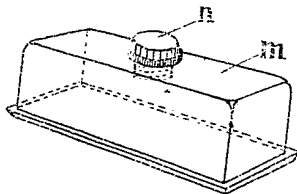

Fig. 7

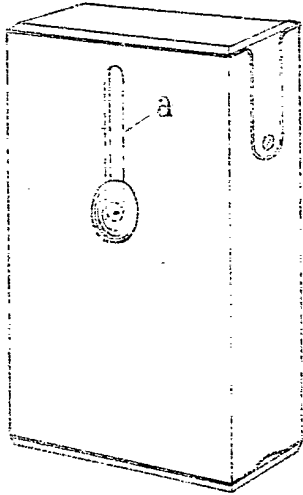

Fig. 9

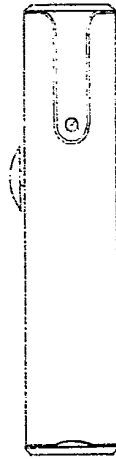

Fig. 8

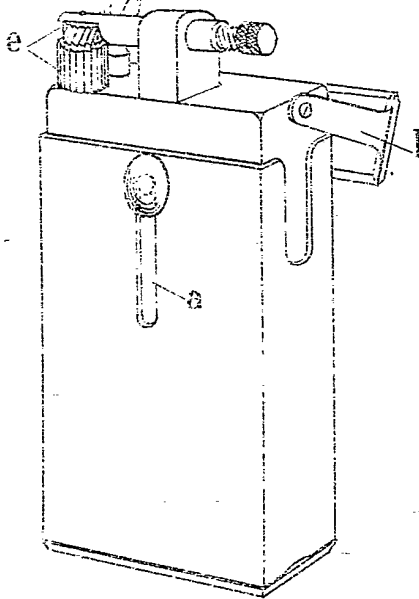

Fig. 10

